

ERIC REPORT RESUME

ERIC ACC. NO. ED 034 105		IS DOCUMENT COPYRIGHTED? YES <input checked="" type="checkbox"/> NO <input type="checkbox"/>	
CH ACC. NO. AA 000 465	P.A. 64	PUBL. DATE 67	ERIC REPRODUCTION RELEASE? YES <input checked="" type="checkbox"/> NO <input type="checkbox"/>
ISSUE RIEAPR70		LEVEL OF AVAILABILITY I <input checked="" type="checkbox"/> II <input type="checkbox"/> III <input type="checkbox"/>	
AUTHOR Olson, Nancy; And Others			
TITLE Teacher's Guide to Water Play: The MATCH Box Project; Prototype Edition.			
SOURCE CODE MGG14325	INSTITUTION (SOURCE)		
SP. AG. CODE RMQ66004	SPONSORING AGENCY		
EDRS PRICE 0.50;3.20	CONTRACT NO. OEC-4-16-019	GRANT NO.	
REPORT NO.	BUREAU NO. BR-5-0710		
AVAILABILITY			
JOURNAL CITATION			
DESCRIPTIVE NOTE 62p.; Appendix to Kresse, Frederick H.; Materials and Activities for Teachers and Children: A Project to Develop and Evaluate Multi-Media Kits for Elementary Schools			
DESCRIPTORS *Multimedia Instruction; Discovery Learning; *Activity Learning; *Instructional Aids; Preschool Education; Educational Equipment; Elementary School Science; Teaching Guides; Learning Experience; *Creative Activities			
IDENTIFIERS *Materials and Activities for Teachers and Children; MATCH Boxes			
ABSTRACT The multimedia kit on water was designed for use by nursery school and first grade children. Water is an intriguing part of a child's world; for this reason, water was chosen as the medium for this set of instructional materials. The child's natural way of exploring his environment is through play; he is really learning ways to discover and experience the world first hand. The box contains such equipment as aprons, mops, pails, tubing, containers of various shapes, funnels, water wheels, pumps, and fountains--all to be used as the child sees fit. There are also photographs, a film and a record to help generate discussion. The teacher's guide consists mainly of large photographs with comments about the activity pictured, poems and quotes from the children, and suggestions of ways to focus their attention on an interesting event. Ways to continue exploring after the kit is returned are presented. A short description of the MATCH Box Project is included. (JY)			

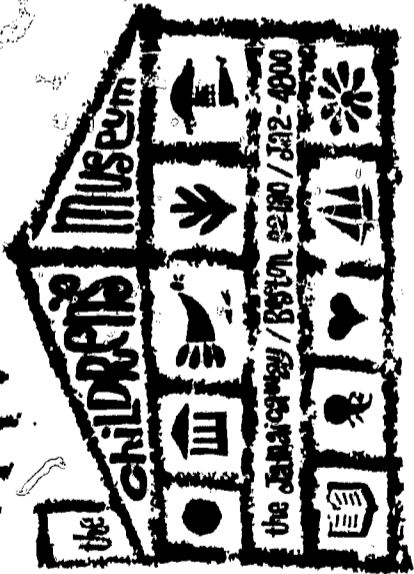

WATER

THE MATCH BOX PROJECT

Materials and Activities for Teachers and Children

ED 034 105

HA000_465

U.S. DEPARTMENT OF HEALTH, EDUCATION & WELFARE
OFFICE OF EDUCATION

THIS DOCUMENT HAS BEEN REPRODUCED EXACTLY AS RECEIVED FROM THE
PERSON OR ORGANIZATION ORIGINATING IT. POINTS OF VIEW OR OPINIONS
STATED DO NOT NECESSARILY REPRESENT OFFICIAL OFFICE OF EDUCATION
POSITION OR POLICY.

MATCH BOX PROJECT

A TEACHER'S GUIDE TO

WALTER

NURSERY - FIRST GRADE

NANCY OLSON & ERMA HIRSCHFELD

"PERMISSION TO REPRODUCE THIS
COPYRIGHTED MATERIAL HAS BEEN GRANTED
BY *The Children's*
Museum
TO ERIC AND ORGANIZATIONS OPERATING
UNDER AGREEMENTS WITH THE U.S. OFFICE OF
EDUCATION. FURTHER REPRODUCTION OUTSIDE
THE ERIC SYSTEM REQUIRES PERMISSION OF
THE COPYRIGHT OWNER."

THE MATERIAL IN THIS PUBLICATION WAS PREPARED UNDER A CONTRACT
WITH THE UNITED STATES OFFICE OF EDUCATION AS AUTHORIZED UNDER
TITLE VII, PART B, OF THE NATIONAL DEFENSE EDUCATION ACT, 1958.

PROTOTYPE EDITION

copyright© by The Children's Museum, 1967
All rights reserved. Printed in the U.S.A.

The Children's Museum is located on the Jamaicaaway at Burroughs Street
in Boston, Massachusetts 02130



I love you, Big World.
I wish I could call you
And tell you a secret:
That I love you, World.

Paul Wollner
Age 7
United States

Water does funny things. It runs through your fingers; you can't hold it. It makes tiny drops and wiggly rivers on windowpanes, and all kinds of puddles in the road. Sometimes it feels cool and silky, and sometimes bubbly. You can stir up a design in it with your fingers or throw stones into it and watch the circles get bigger and bigger. If you didn't have any water, you couldn't build a sandcastle or make mud pies, or sail a stick in the gutter.



Wherever there is water, there is an invitation to every child for dabbling and splashing. What child can resist wading through the middle of the deepest puddle, or running through the stinging, tickling spray from the garden hose, or playing in the warm, soapy water of the kitchen sink?

Water is an intriguing part of a young child's world; for this reason, we chose water as the medium for a box which is really about developing ways to discover, to experience, and to explore. The child's natural way of exploring his environment is through play. Playing with water, the child can find lively opportunities to learn how to search out his world.

Contents

Before You Begin	1
Materials	4
Waterplay	9
Exploration Beyond the Box	35
Acknowledgements	44
About the MATCH Box Project	46



BEFORE YOU BEGIN

In this teacher's guide we have tried by way of photographs to capture some of the intense involvement of children with water. Our photographs were taken during classroom tryouts when the waterplay materials and ideas were being developed. With some photographs appear the words of the children as they worked with the materials, and the comments of the teachers as they helped focus the children's attention on some new wonder. In other photographs, the expressions on the faces of the children speak for themselves.

The Guide also contains several poems. They are also the words of children, taken from Richard Lewis' collection, Miracles. The poems have an honesty of expression that comes when children are free from adult impositions - in this case, editing. We observed the same honesty of expression in the way the children in the photographs played with water when they were on their own, free from the impositions of adult planning. Some of the children in your class may enjoy hearing the poems read aloud. You may even find them chanting their own verses when the mood is right.

The sequence of the photographs suggests the general sequence waterplay usually takes: from the simple to the complex. With this in mind, you might begin with a few of the simpler materials such as cups, funnels and squeeze bottles. Putting out too many things at one time may distract the child rather than enrich his play. Other materials that do unique and complicated things, such as the U tube, the spiral tube, the set of rigid and flexible tubing and the water system, may be added later, after the children have had time to explore the more familiar materials. You will undoubtedly find that the more extensive the child's experiences are, the richer and more lively his explorations will be with each new object.

Your best guide for deciding sequence will be the children. Watch and listen to each child. Needless to say, many activities can go on simultaneously as each child fits the materials to his own learning level.



You may wonder how much specific direction the child will need. We have found that very little is necessary or even desirable. Things happen very naturally when children, water, and materials come together. You will find that as the child plays, he becomes increasingly aware of what is happening. If he can become aware of things on his own, something very special has happened. He will want to share his discoveries with you or his friends. Don't be disturbed if the path on which the child's own explorations take him seems devious or even dubious. You can be sure that whatever he is doing with intensity has meaning for him. Sometime he may need your help: with only a word or a question you can encourage him to look more deeply yet still allow him the freedom and flexibility to explore the world of water creatively, at his own pace.



waterplay materials

aprons
mop
sponge
pail

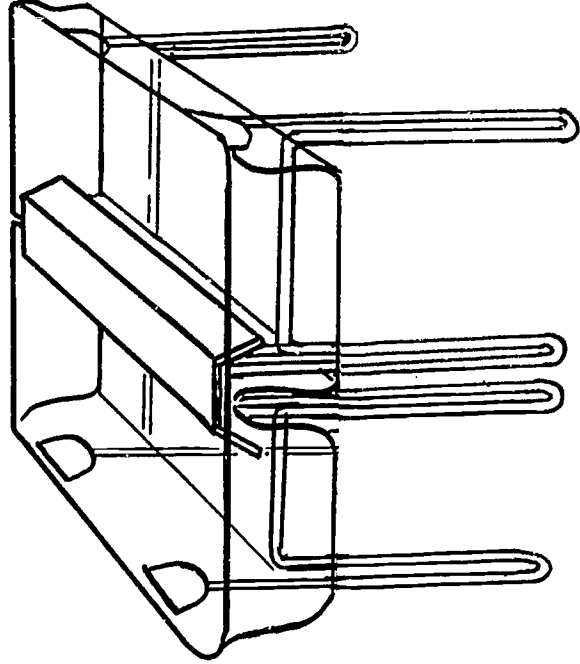
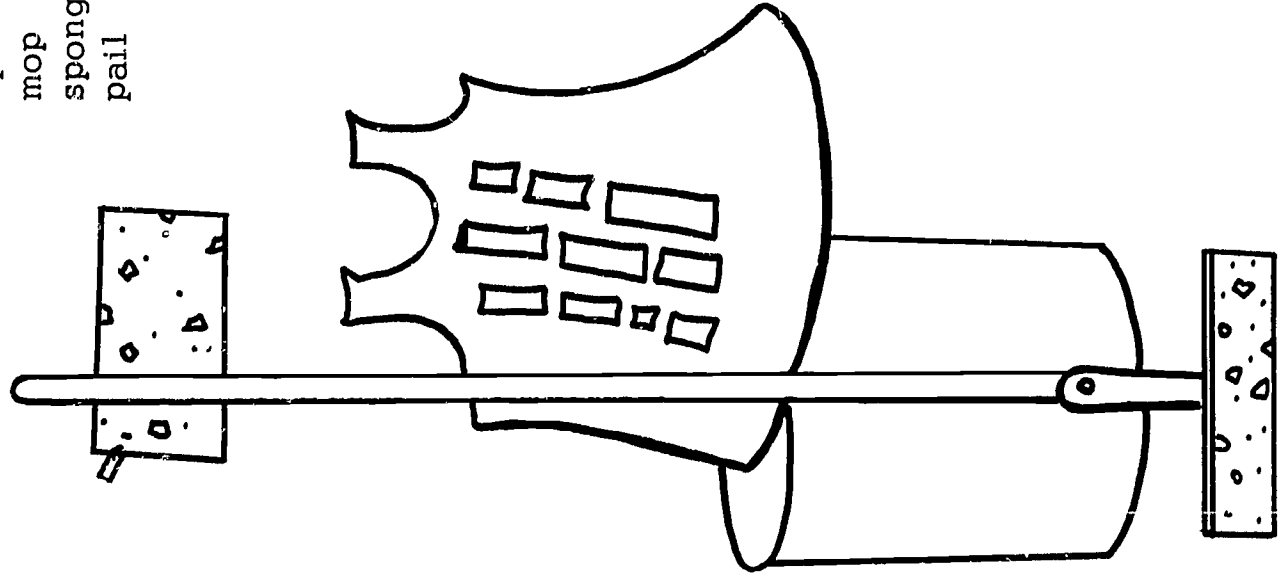

two tubs
(clear plastic)
legs
joining shelf

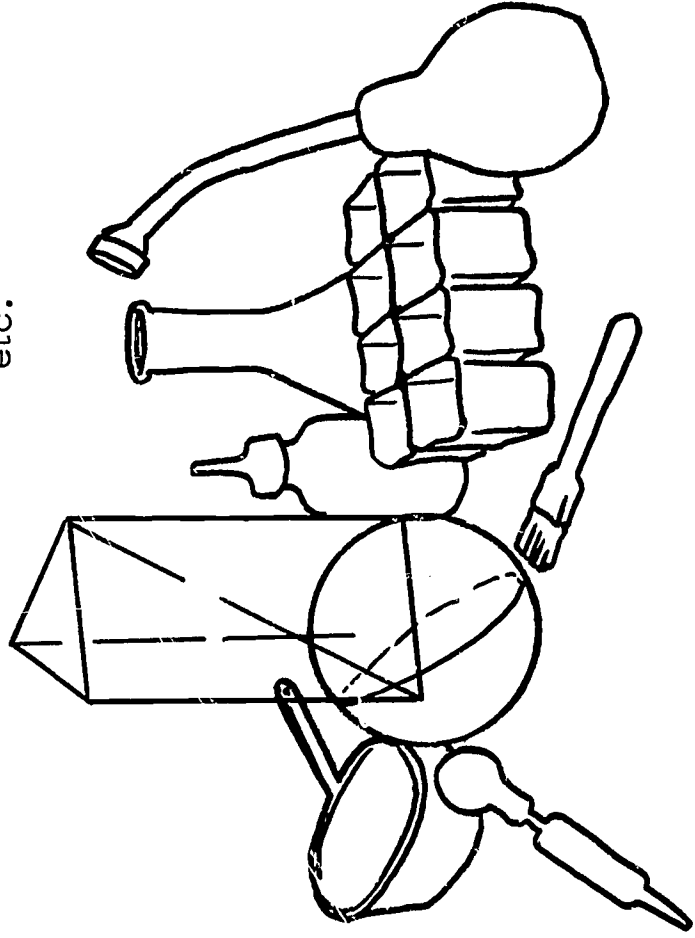

funnels
squeeze bottles
pumps
tetrahedrons
test tubes
cups
syringes
paint brushes
egg cartons
bottles
spheres with holes
measuring spoons
pumps
etc.

teacher's guide
photographs
film
record

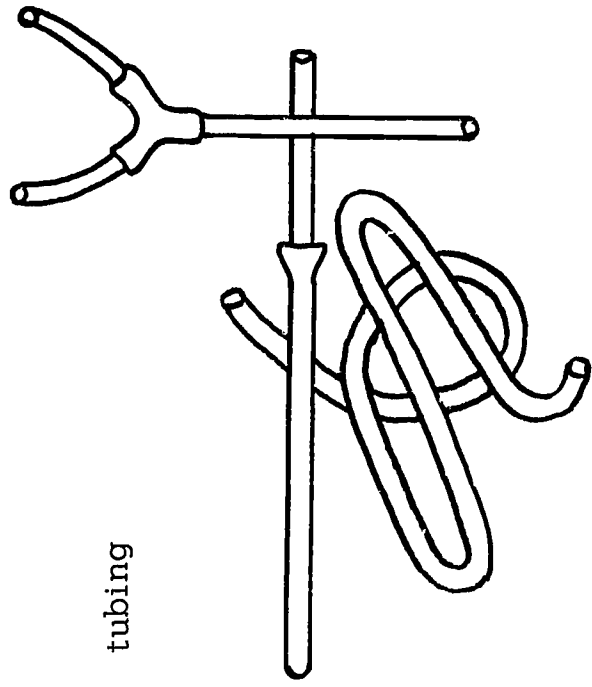
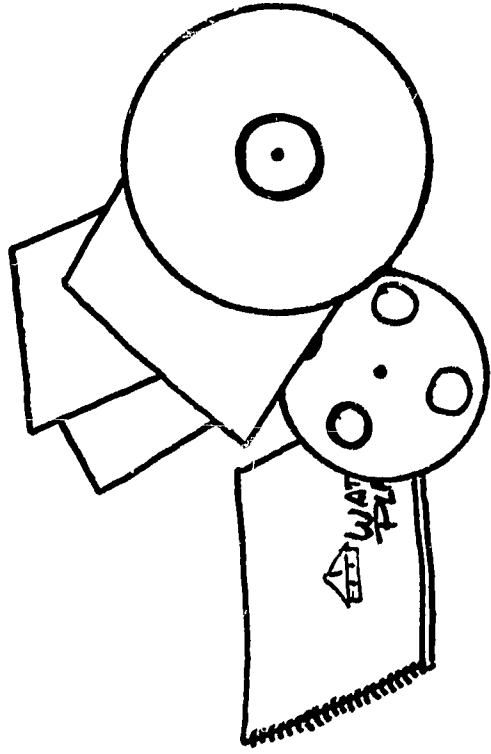

tubing

Information on ① assembling tubs
and ② packaging is on the flaps
of the bags your Waterplay Box
comes in.

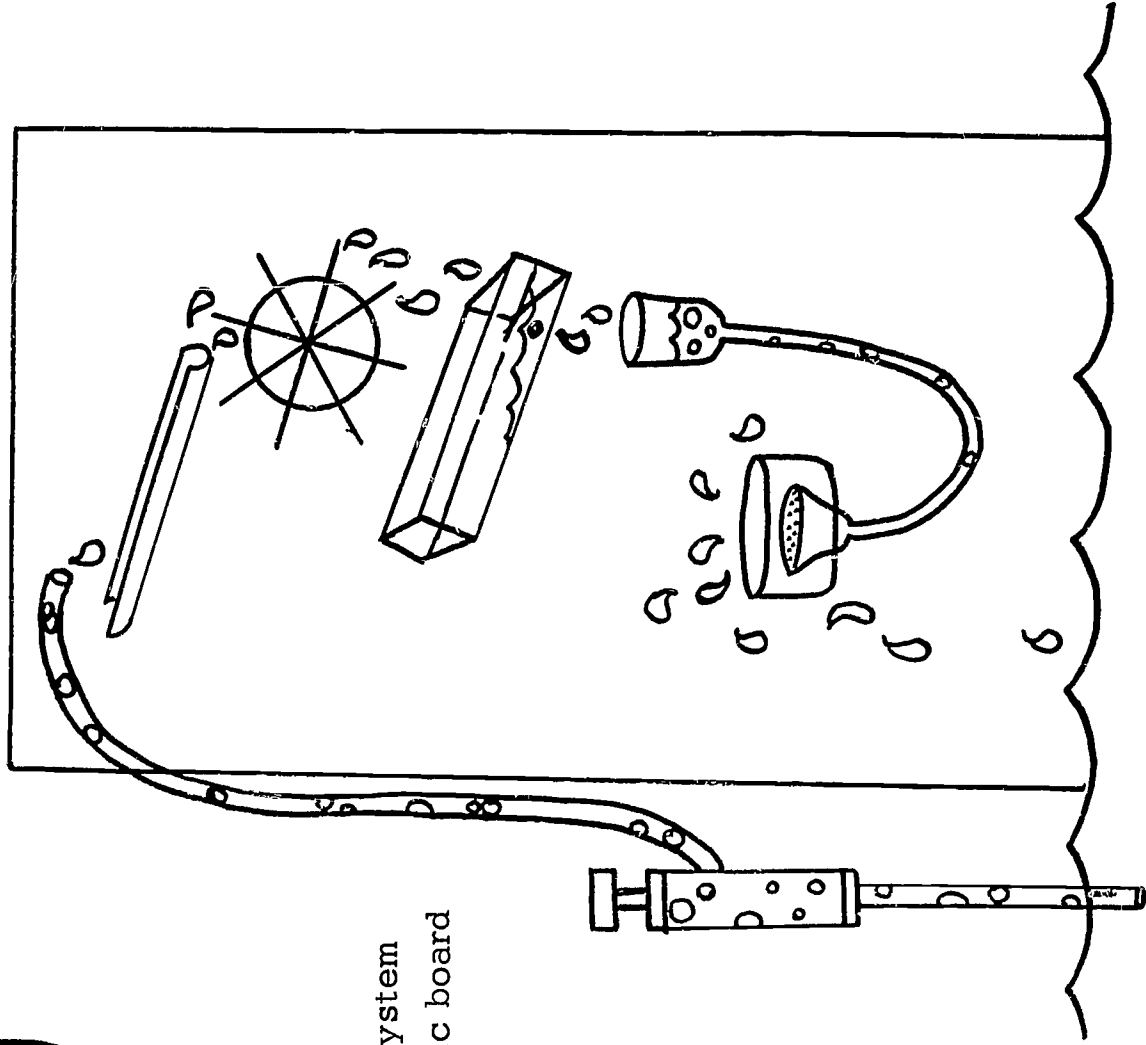

water system
magnetic board

Notes on materials

Throughout the Waterplay section which follows are occasional asterisks. They refer you to this page of notes.

MEASURING * pp. 20 - 21

Set of STANDARD MEASURES included in the Box:

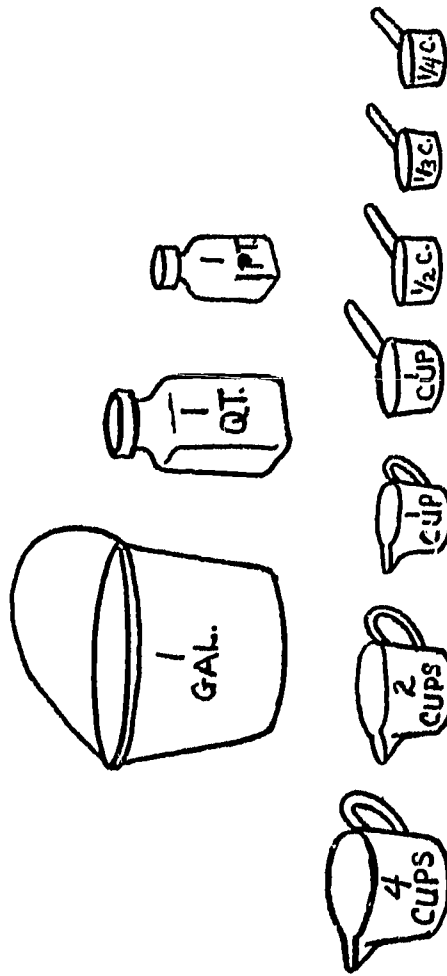

One of several EQUAL-VOLUME sets in the Box:

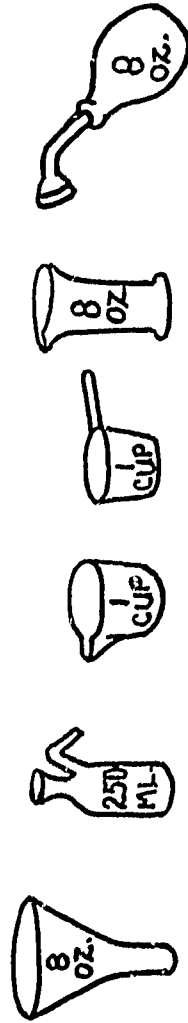

Approximate U.S. equivalents for containers marked in milliliters.

125 ml. = 4 oz.

250 ml. = 8 oz.

TUBING * pp. 24 - 26

Two kinds of tubing in the Box:



To attach the flexible tubing, push the enlarged end over the small end of the tube like this:



To connect the rigid tubing, use:

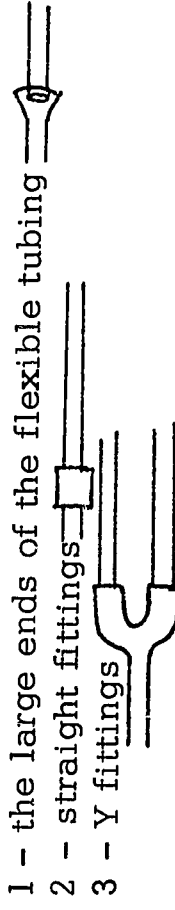

Funnels facilitate pouring water into tubes.

2 oz. funnels filter into:

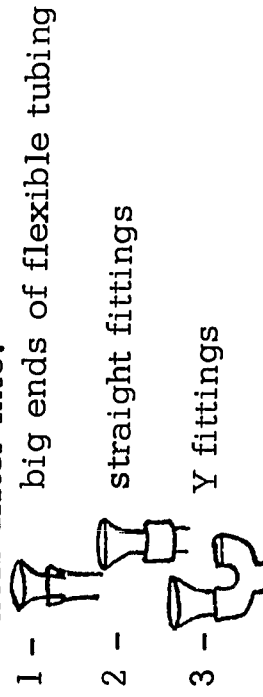

To remove fittings, turn them as you pull. The children will need help with this. Their natural way to remove the fitting is to give a straight, hard tug. This only makes them tighter.

WATER SYSTEM

PARTS * pp. 28 - 29

1 MAGNETIC BOARD: to assemble:

1. Slide the two sections into grooves in the middle of the shelf. (The board then rests on the shelf and on the tank bottoms.)
2. Swing legs out.
3. Clip the two sections together.

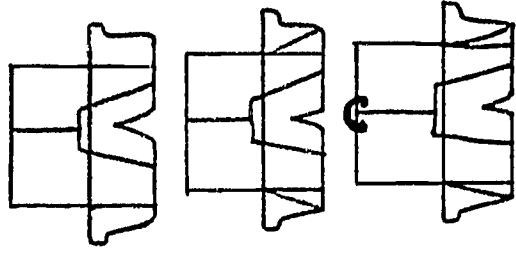

Use both sides. The holes enable the children to join together the systems on both sides of the board with the tubing.



4 TROUGHES: to catch and direct water to the next part.



1 RESERVOIR WITH OUTLET: to catch water.

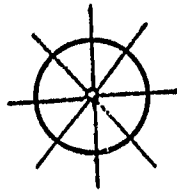

3 WATER WHEELS: to move water.
2 overshot
1 turbine

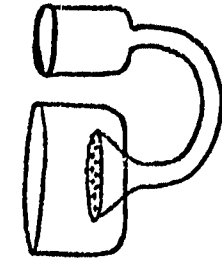

1 FOUNTAIN: to make the fountain work, the reservoir cup must be placed higher than the spray head. Children enjoy discovering this.

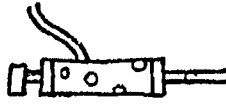

2 PUMPS: to provide water power.
1 vacuum
1 syphon

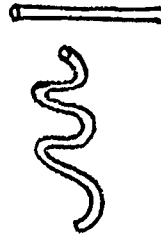

TUBES: to connect other parts.
1 flexible
1 rigid
Hold them to the board with clamps.



8 CLAMPS: to hold tubes.

waterplay

6/8

5

Most children are delighted with even the routine jobs, such as filling and emptying the tanks. There are many ways to focus their attention on the good things that happen. (Suggestions of ways to focus attention are often written next to photographs, as here. Children's words are always written within quotations marks.)



Watch Tommy's face through
the bottom as I pour the water in.

What happens to the bubbles?
What color are they?

Does the water do anything
to the pencil I just put in
the tank?

What does your hand feel like
against the water?

Would anyone else like to fill the tanks?...

"I got giant hands."
"Mine look all wrinkled."
"The water's tickly!"



Give the children plenty of time for exploration through play. Often they get so absorbed in what they are doing themselves that suggestions from the teacher only drag them away from something important rather than lead them into it.





SPLISH SPLOSH
I feel
 drops of rain,
And it goes;
SPLISH! SPLOSH!
 on my head.
And sometimes it goes;
SPLASH! BANG! CRASH!
 on my coconut!

Stefan Martul
Age 7
New Zealand

How can you make the bubble bigger or smaller? Can you make it go faster?



RAIN

The rain screws up its face
and falls to bits.

Then it makes itself again
only the rain can make itself again.

Adrian Keith Smith

Age 4

New Zealand

Can you make the water come out in a thin
stream, drop-by-drop? Can you keep it from
coming out at all?



What new colors can you make with the food coloring?

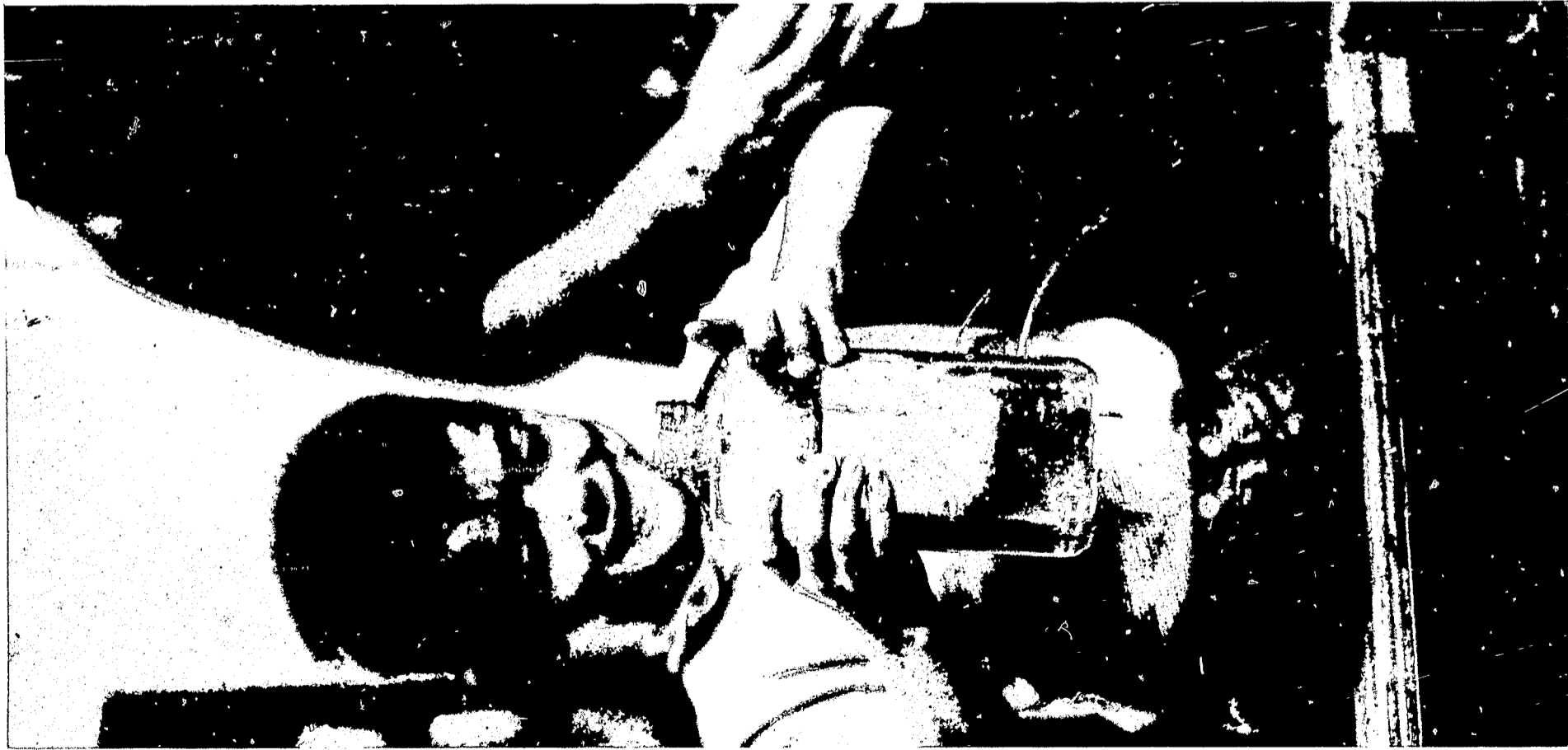

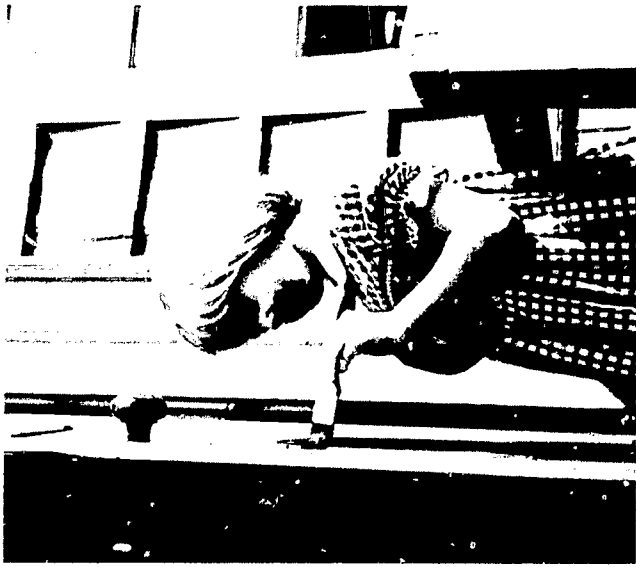

Try to make the suction disc fit tightly to the side of the tank. Will it hold the bottle?

Can you guess before you try which bottle will give the thinnest stream of water?



BUBBLES
AND
BUBBLE
WANDS

Bubbles and bubble wands can be fascinating on a sunny day in the school yard. Beautiful things can be done indoors as well.

- Funnels with plastic straws make grand bubbles.

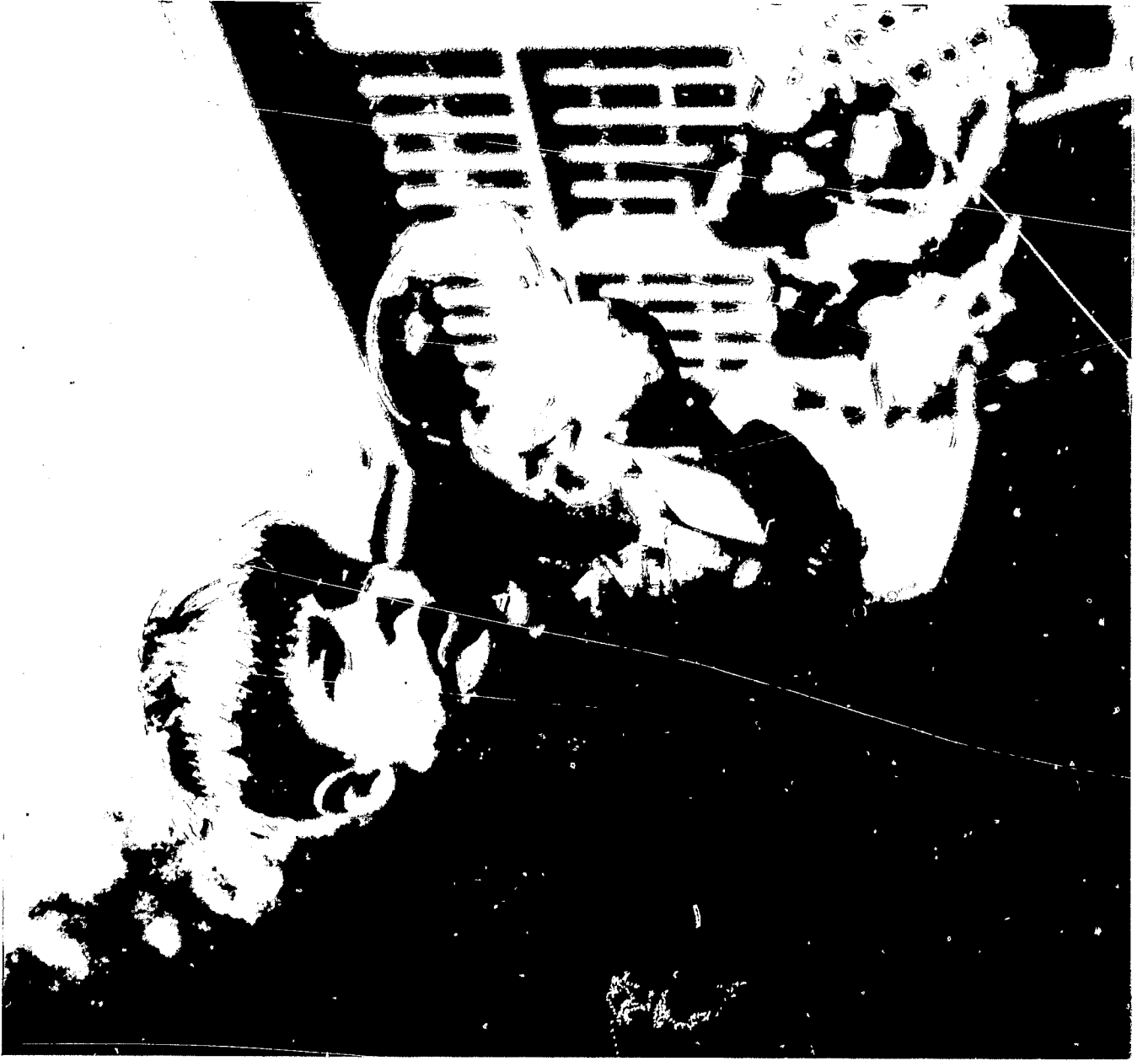

"I've caught it! I've caught it!"

Can you cut it in two?

Touch it on one side and see what happens.
"It's alive! It made a different shape!"



"Mine has rainbows."
"It's wiggling."

What happens if you
touch it with a wet
finger? A dry finger?

"I'm painting what I saw in my bubble."

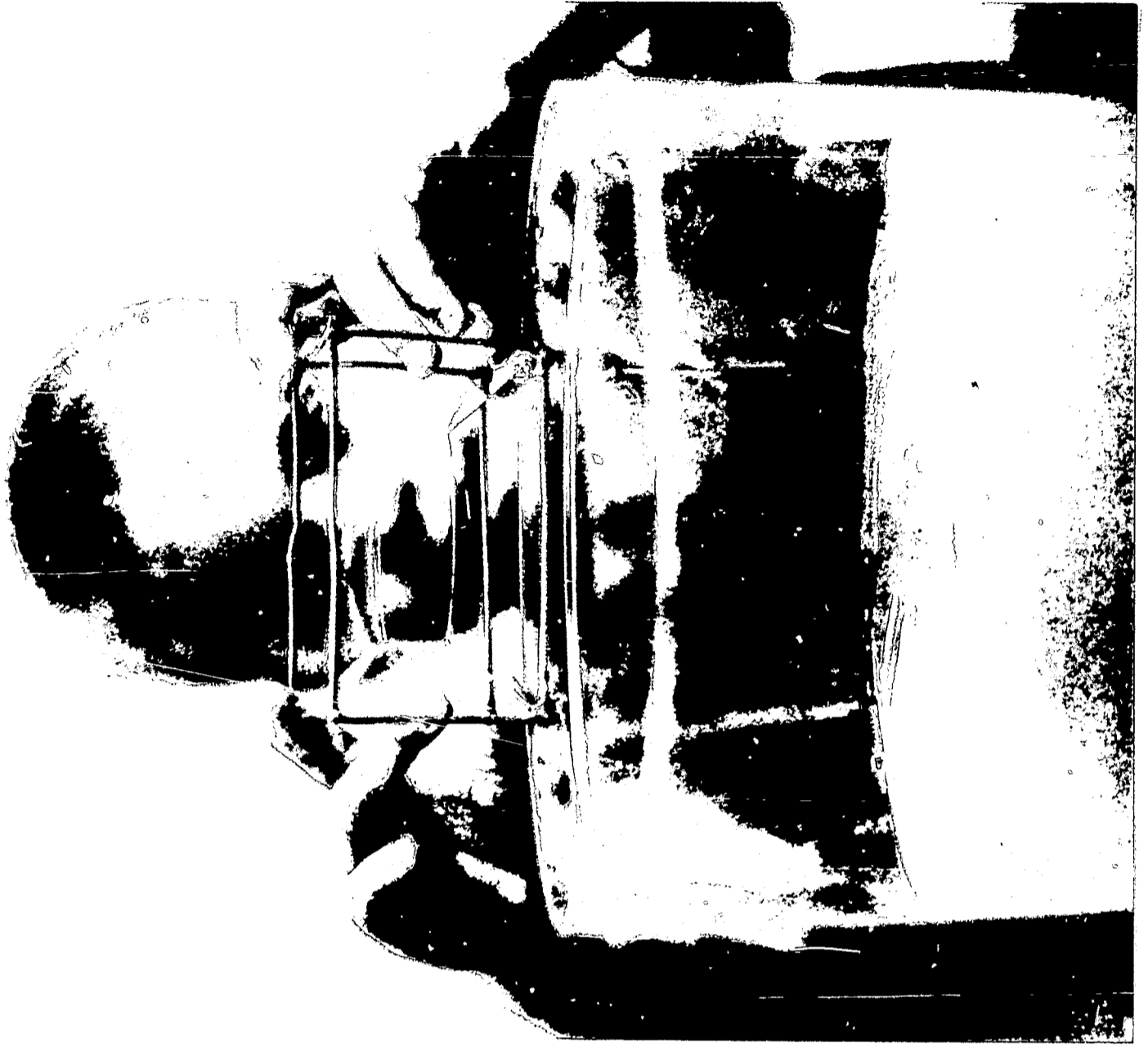

MEASURING *

Can you find a container that you think will hold the same amount of water I have in this funnel?



Which of these containers would you use if you wanted to fill the bucket quickly?
Guess how many quart bottles it will take to fill this gallon bucket?
Now let's see...



"Then mix it and put it on
the table for the customer."



**FLOATING
AND
SINKING**

Have a scavenger hunt to collect odds and ends for floating and sinking.



"This seed could float down a stream and grow far away."



Let's play Guess.
Before you put those
things in the water,
can you Guess whether
they will float or sink?
How can you tell?



"This is going to float. It's light as
a feather...Hey, it went to the bot-
tom!"

TUBING *

- ♦ Try adding food coloring to the water.



"This is gonna be a watersnake!"
"I got a necklace!"
"Hey, the water's stuck!"

Can you guess why the water goes through differently if you hold the tube upside down?

How high is the water in each side of the U tube?
Can you change the level?





● A child may discover how to siphon on his own...

How can you fill your pail from the large tank with only this tube?

● ...Or you may teach him. To start a siphon flowing, hold a piece of tubing under water until it is filled. Make sure there are no bubbles in it. Seal the opening at each end with a finger. Hold one end under water while the other end is released into an empty container outside and below the tank.

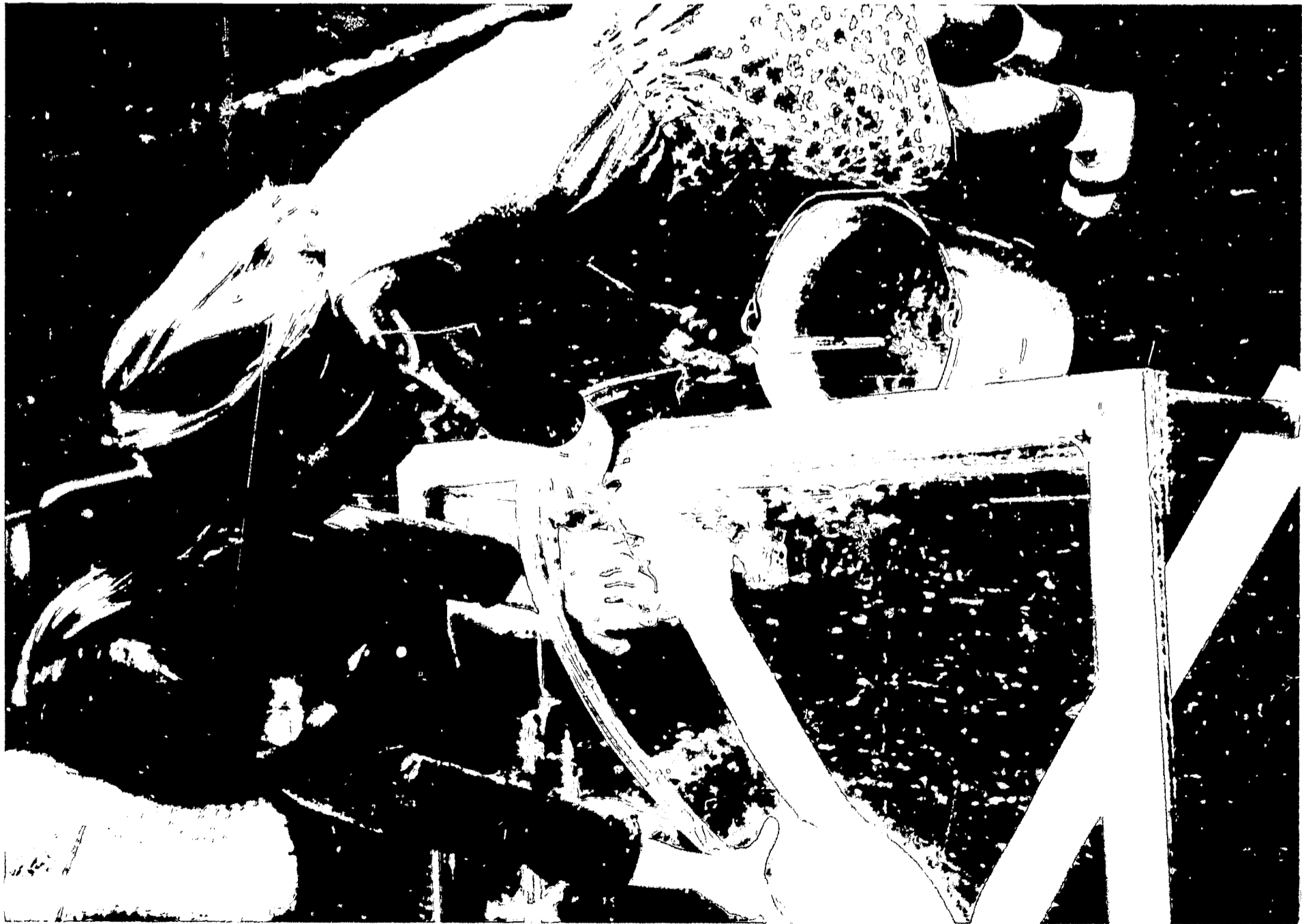

MIXING and
DISSOLVING



What happens if
you squeeze a
drop of salad oil
onto water?

There are many different liquids
and powders you may collect for
the children to experiment with:

Liquids: food coloring

salad oil

alcohol

liquid soap

Powders: sand

salt

cornstarch

soda

sugar

Remember to wash away the oil
with soap and hot water.



WATER *
SYSTEM

- Being able to use the parts separately or just two of them together in a kind of free play can be a good preliminary to building something more complicated - and just as satisfying.



● Cooperation among the children helps to build a complicated water system.

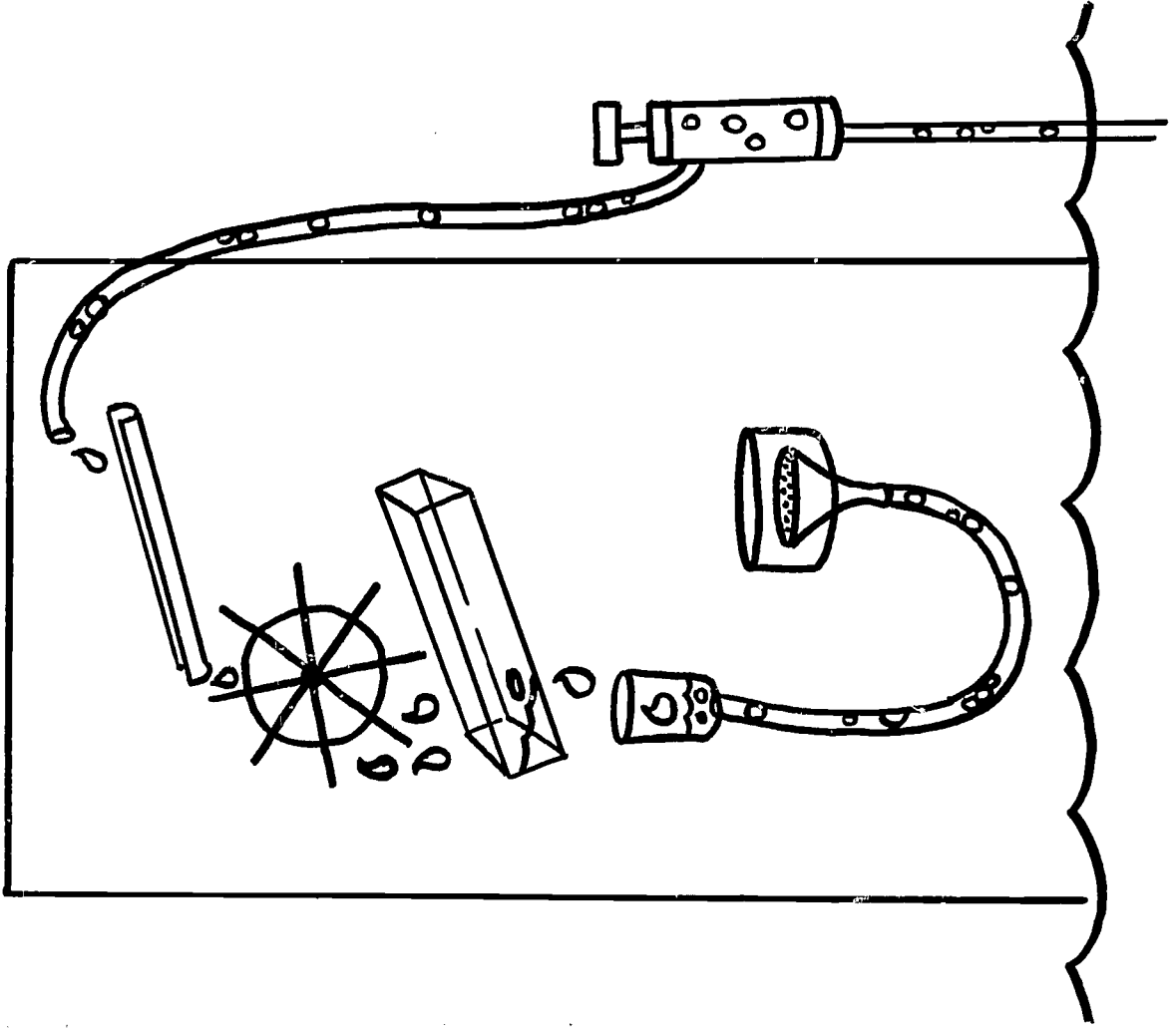

Can you pump water to the system?

"Let's make it connect to there."

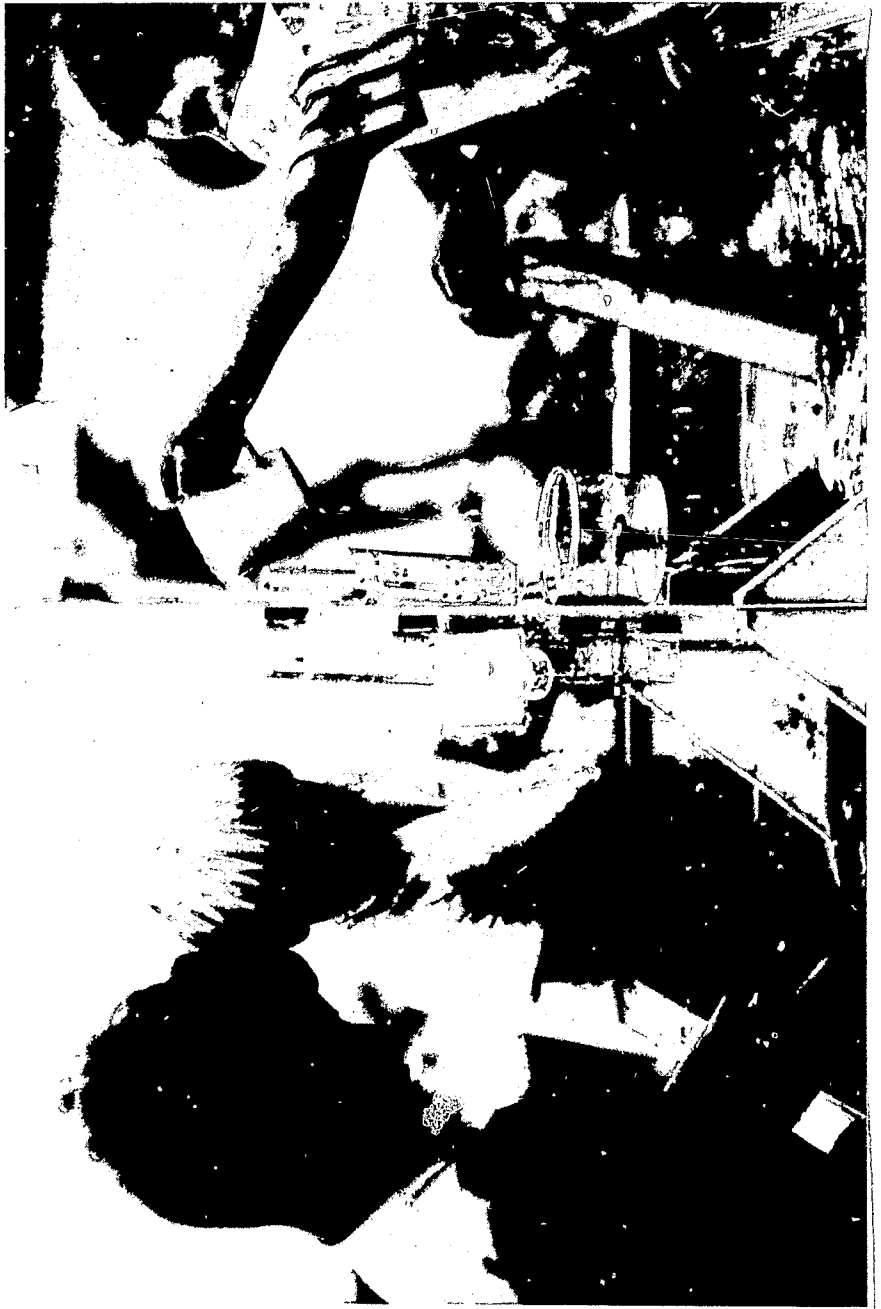

SOUNDS

Some children like to go off into a corner with a small tray full of water and experiment with the water sounds made by spray bottles, turkey basters and the like.



"What's making the sound?"
"The green sprayer thing?"



"That sounds like my dog drinking."

The record contains water sounds recorded both in the house and out of doors. Allow the children to play the record by themselves whenever they wish. Don't worry too much about scratches. Because we feel that it's important for the child to listen at his own pace and in his own time, we are willing to furnish a new record whenever one is needed.

PHOTOGRAPHS

- The photographs can be used in many ways:
 - just for looking
 - for story telling
 - for matching with the sounds on side #2



"Who has a picture that goes with this sound?"

FILM

This five minute film follows a few children through puddly streets to a park. There they splash and play and do all the things children do in a pool. The camera takes the eye close to beads of water, hands rippling the water, feet sloshing through puddles, sunlight glinting off slick water surfaces -- things you see and feel only when you are really engrossed in the play.

CLEAN-UP
TIME

Cleaning up can be just as much fun as getting started. Take advantage of the siphoning technique that has been learned and of all the able and willing workers that you have around you!





MOP SONGS

Back and forth
and
Back and forth
and

Splop! splop! squish!

Mrs. Donovan's
Kindergarten
Brookline, Mass.

Wipe it up
and
Dry it up
and
Get it wet again!

Andy Hefferman
Age 5
Brookline, Mass.

EXPLORATIONS beyond THE box

Perhaps these photographs
may help suggest similar things
your own class might do to
follow-up their explorations
and observations with water.



WONDERING

As I lie here wondering
I feel an angry sweeping gust whirl around
my legs.
The grass bustles about like a green jungle.
The leaves flap about,
As paper whirls around the playground.
The seagulls squabble over scraps
And look greedily for more.
Little insects crawl through the grass
jungle
Like wild animals
In the small world I know little about.
I lie here wondering.

Kelvin Windsor
Age 10
New Zealand

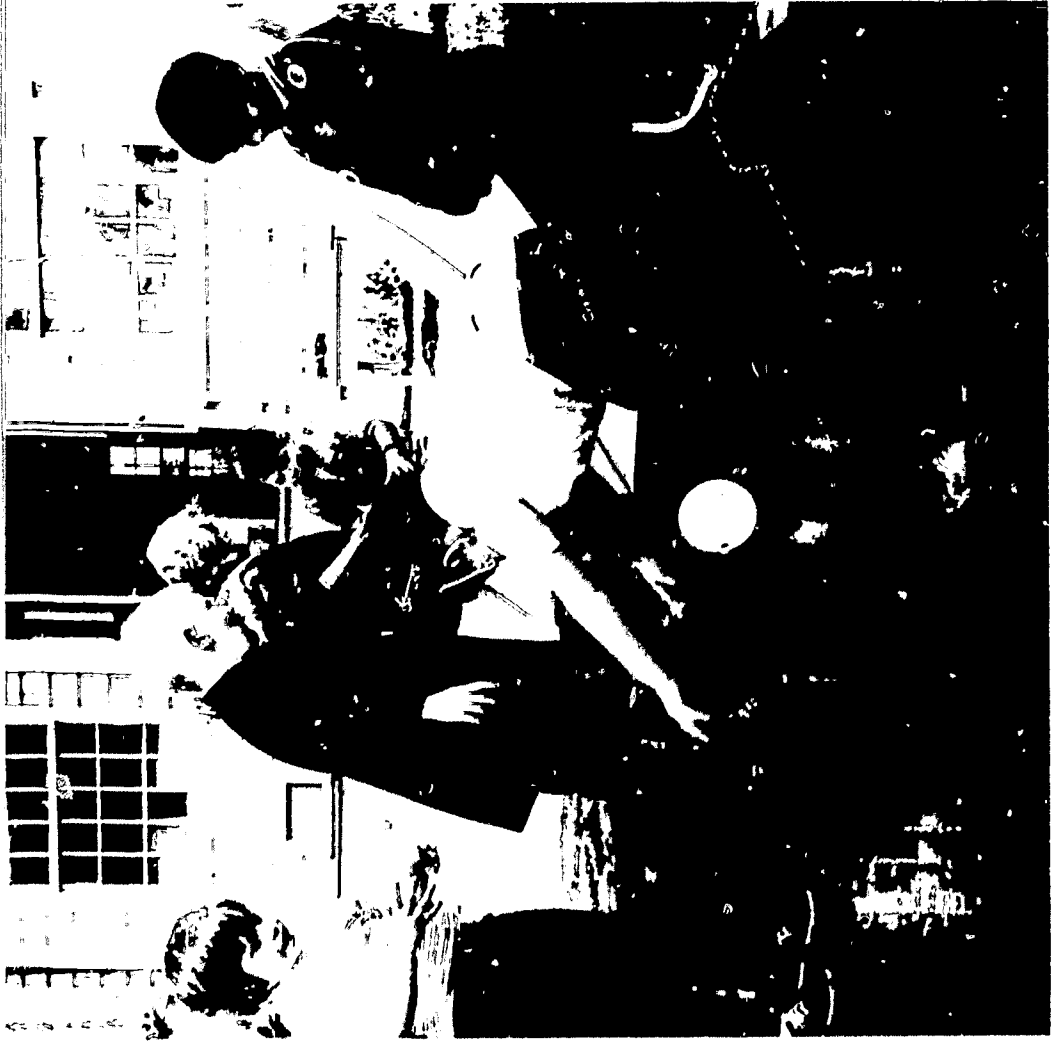

MIRROR! MIRROR!

As I look into the mirror I see my face.
Then I talk to myself.
Then I play like I am in jail.
I pretend that I am bad.
I pretend sometimes that I am on a stage.
I sing to myself. I introduce people.

Deborah Ensign
Age 7
United States

THE FLYING SEA

The sea rolls by.
It's like bombs exploding
And when the roll fades away
The flying sea sings.

Roger Mortimer
Age 7
New Zealand



THE PIER

One very nice day I went to the pier,
There were lots of noises that I could hear,
There I saw so many ships.
They were buzzing; buzzing, buzzing
I couldn't stand it, there was so much noise --
As if the place was full of naughty schoolboys.
However, I didn't want to leave. I had to be brave
Because I was enjoying myself, looking at the waves.
Soon I had to go; night had come, lights went on,
The day had brought me so much fun.
That night I could not sleep; I wanted to sing,
Of ships and waves and bells that ring.

Enrique Lozada
Age 10
Philippines

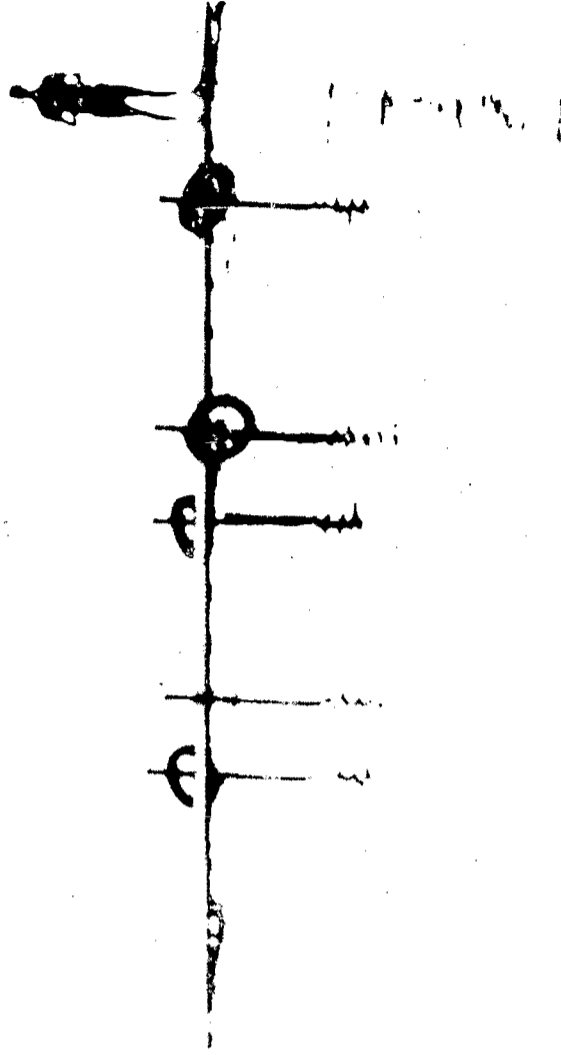

RAIN DANCE

The pattering rain dances,
Like a lovely maiden,
Waltzing in the wind.
Blithe breezes stroke their harps,
As clouds leap in step with misty partners,
Trying to embrace the thirsty earth.

Barbara Krasnoff
Age 9
United States

(...while playing Debussy's "La Mer,"
Smetana's "The Moldau," or any other
"water" music...)

Listen to the waves...
Be the waves -- swelling and foaming
and crashing.





Can you draw a design on the water?

Can you make your water design into a paint design?



YOUR
OWN
WATERPLAY

Waterplay doesn't have to end when the box is returned. It's easy to collect your own materials so the children's explorations can continue. Your sources of free or inexpensive supplies are hardware stores, dime stores, supermarkets -- and parents who are willing to send in the "empties" from a number of commercial products they have used. Here are some suggestions:

- plastic wading pool
- wash tub
- baby bath
- garden hose
- hollow plastic jumping rope
- coffee cans
- plastic bleach bottles
- plastic mustard bottles
- TV dinner tins
- milk and cream cartons
- plastic shoe boxes, blouse boxes, etc.





Acknowledgements

Special thanks go to the following people for helping us create the Waterplay Box...

The teachers who tried out our ideas and made helpful suggestions:

Mrs. Betsye Sargent, Shady Hill School, Cambridge
Mrs. Mary Persons, Community School, Dorchester
Mrs. Priscilla Ehrlich, Shady Hill School, Cambridge
Mrs. Florence Donovan, Pierce School, Brookline
Mrs. Harriet Gaetz, Pierce School, Brookline
Miss Linda Earle, College Work Study Program, The Children's Museum

The artisans who helped produce the materials:

Mr. Bruce Perry - water system production
Mr. David Aldrich - the film
Mr. Wil Morton - the record
Mr. Jeremy Berndt - guide photographer
Mr. Fred Brink - photographs
Mr. D'Aracy Marsh - photographs
Mr. Skip Schields - photographs
Miss Nancy Olson - photographs
Miss Linda Earle - various and sundries, willingly and well
Mrs. Signe Hanson - guide layout and graphic art
Prof. Richard Castner - editorial supervision
Miss Susan Phelps - cover design
Mrs. Betsye Sargent - apron design
Miss Sally Aschengrau, Miss Ellen Geisler, Mrs. Fred Kresse - apron sewing
Mr. Bruce Sargent - silk-screening
Mr. Duncan Smith - design consultant
Mr. Robert Walker - design technician
Mr. Allan Conrad - design technician
Simon and Schuster, Publishers, for permission to use poems from Richard Lewis' Miracles, copyright 1966.

Mrs. Betsye Sargent, Mr. Fred Kresse, and the MATCH Box Staff for ideas and criticism.

Nancy Olson
Erma Hirschfeld
co-leaders

About the MATCH Box Project

The MATCH Box Project is concerned with how real objects together with other materials can be used to make teaching and learning in elementary schools more meaningful and fun.

For teaching and learning to occur there must be communication. Mostly we use words to communicate in the classroom. We try to do practically everything with them. But there are people for whom this is not the best way, and there are ideas and experiences and insights which words can only hint at or not convey at all. If we want to teach many things to many people, we must commit ourselves to using many ways.

MATCH Boxes are systems of materials and activities that communicate in a variety of ways. Built around specific topics, they contain objects of all sorts, films, pictures, games, recordings, projectors, supplies, and a pattern for using these things - the Teacher's Guide.

Each MATCH Box is unique - a probe into the realm of non-verbal learning. Since 1964 when the Project began, 16 of them in prototype form have been developed and tested in the schools.

First Generation - completed September 1965

Grouping Birds	K - 2
The City	1 - 3
The Algonquins	3, 4
Seeds	3, 4
A House of Ancient Greece	5, 6

Second Generation - completed September 1966

Houses	1 - 3
Animal Camouflage	2, 3
Netsilik Eskimos	3, 4
Musical Sounds and Shapes	3, 4
Rocks	5, 6
Japanese Family 1966	5, 6
Medieval People	5, 6

Third Generation - completed September 1967

Waterplay	Nursery - 2
Imagination Unlimited	3, 4
"Paddle-to-the-Sea"	4 - 6
The MATCH Box Press	5, 6

water play

